

8 7 6 5 4 3 2 1

R52-DM50

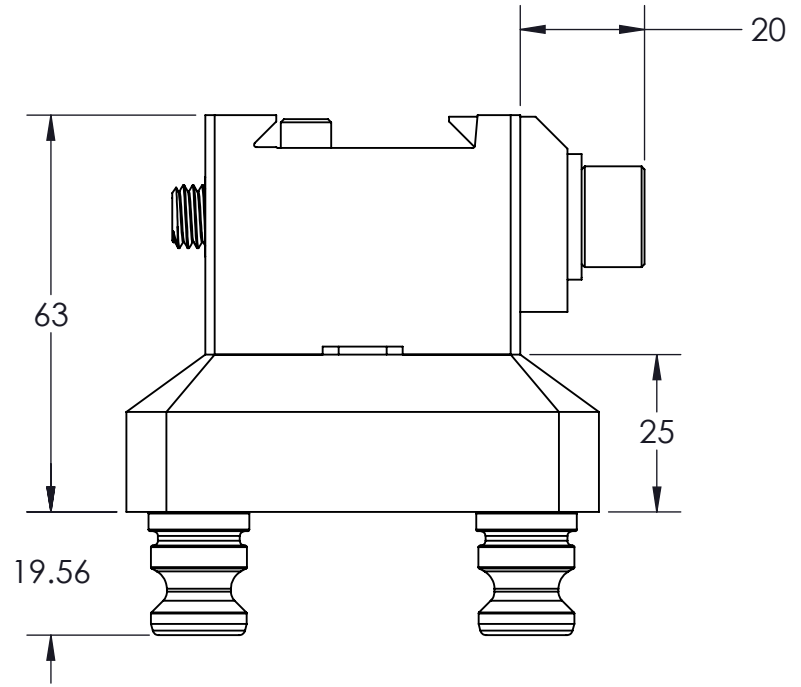
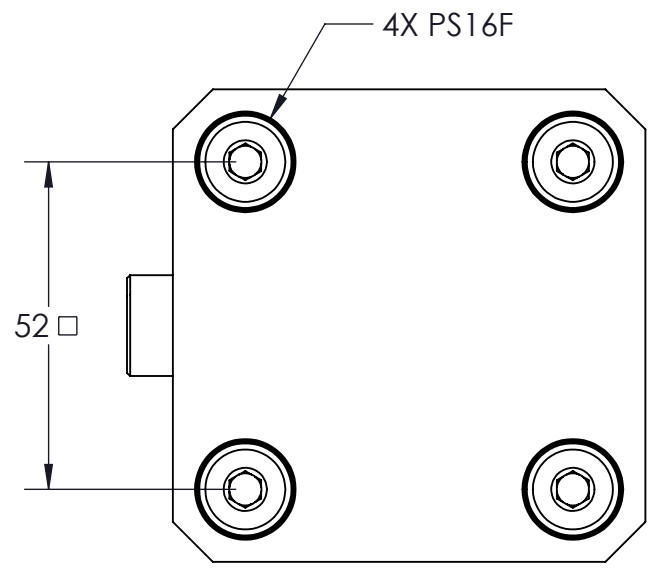
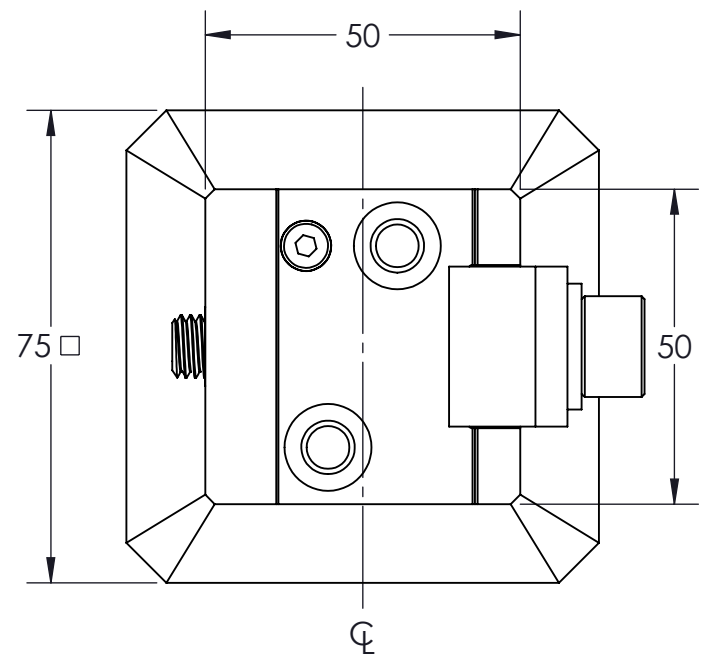
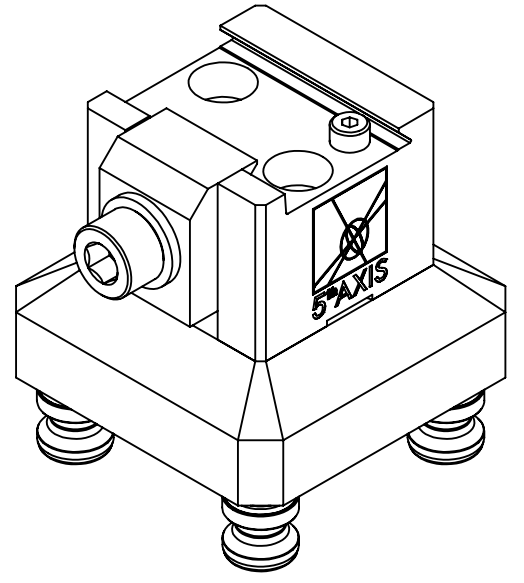

MILLIMETER <small>DRAWN IN ACCORDANCE WITH ASME Y14.5-2009</small> PROPRIETARY AND CONFIDENTIAL <small>THE INFORMATION CONTAINED IN THIS DRAWING IS THE SOLE PROPERTY OF FIFTH AXIS, INC. ANY REPRODUCTION IN PART OR AS A WHOLE WITHOUT THE WRITTEN PERMISSION OF FIFTH AXIS, INC. IS PROHIBITED.</small>	TOLERANCES <small>UNLESS OTHERWISE SPECIFIED</small> X ± 1.0 .X ± 0.3 ANGLULAR ± 0.5° .XX ± 0.13	5th AXIS <small>WWW.FIFTHAXIS.COM 7140 ENGINEER ROAD SAN DIEGO, CA 92111 P (858) 505-0432 F (858) 505-9344</small>		
	<small>THIRD ANGLE PROJECTION</small> 		DESCRIPTION ROCKLOCK™ 52MM DM50 FIXTURE	
SIZE B	PART NO. R52-DM50	REV A		
<small>DO NOT SCALE DRAWING</small>		<small>SCALE 1:1</small>	<small>WEIGHT:</small>	<small>SHEET 1 OF 1</small>

8 7 6 5 4 3 2 1